

Basic Origami Instructions Symbols Making Square Paper

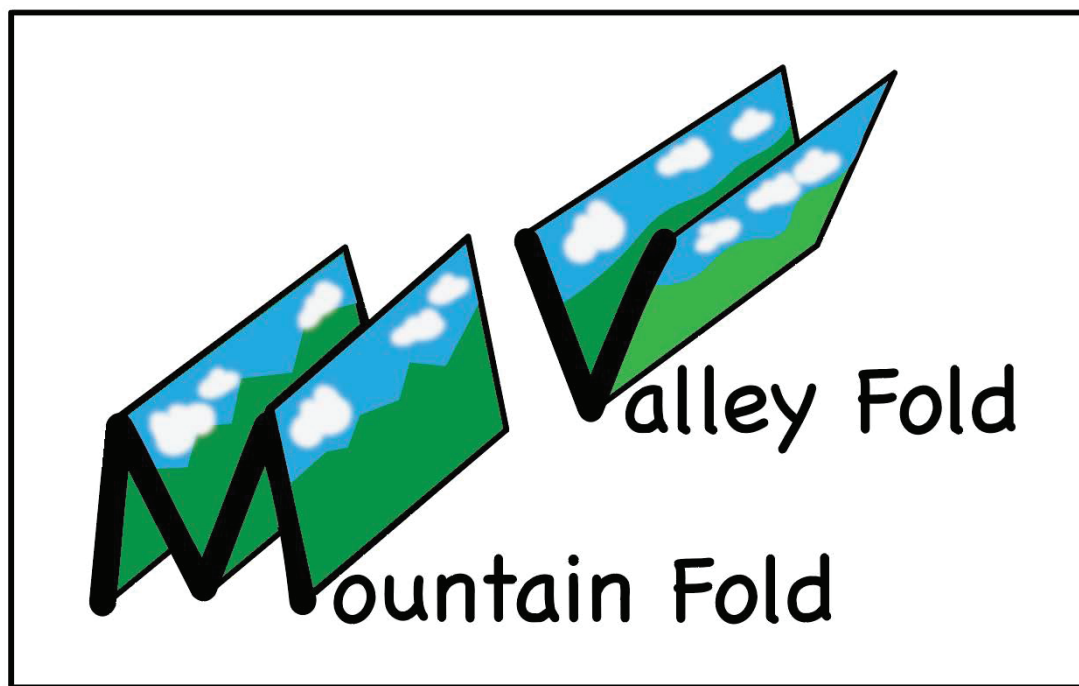

Hello Teachers,

Thank you for downloading this handout. After decades of teaching, now I'm sharing activities I designed for my classes and some new ones as well.

Please visit UnCommon-Core.com. While you are there, sign up for your free copy of **Colorful Collections: A Mindful Exploration of Proper Fractions**.

In addition to **Colorful Collections**, you will receive a Wednesday morning email with teacher tips, educational ideas, or a free version of whatever I'm working on at the moment. You get to use it for free, and I benefit from your questions and comments.

Also, visit my Teachers Pay Teachers store Uncommon-Core dot com.

Thank you again. All the best,

Isabelle

Isabelle Hoag M.Ed.
Director of Education
UnCommon-Core.com



Make a Square from Printer Paper

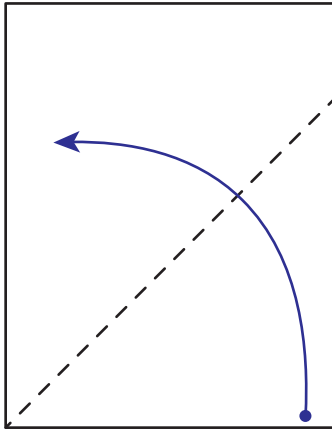

Finding a square within a rectangle is simple. Bring one of the corners from the bottom up until the bottom edge of the paper aligns with the vertical side. Keeping the point in place, crease as shown. Then use one of the two methods below to make a square.

Usually, you will fold along this line and then cut the page along the horizontal fold.

If you have some beautiful paper that you cannot bear to cut, consider folding it back as below.

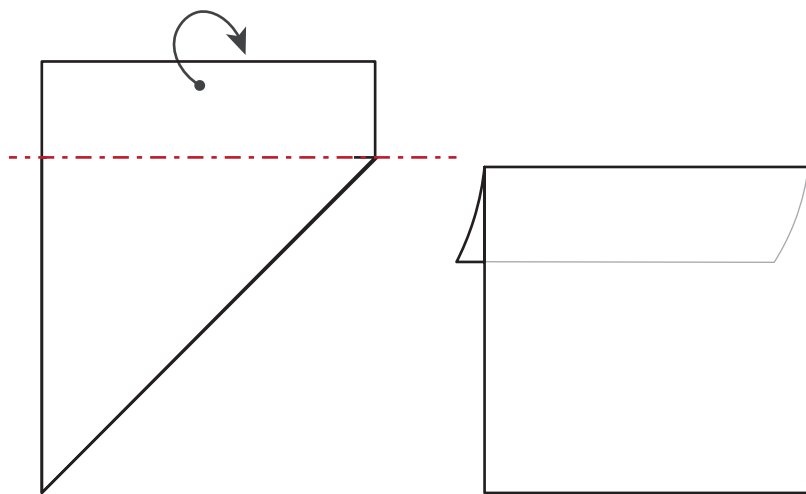
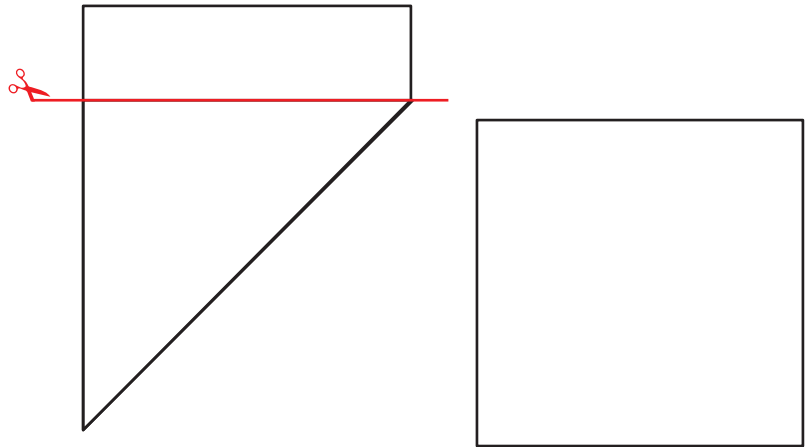

Fold extra paper to the back. Create your origami model as if this piece of paper is not there. It will be easier with some models than others.

Origami Symbols and Vocabulary

A valley fold on top is a mountain fold underneath.

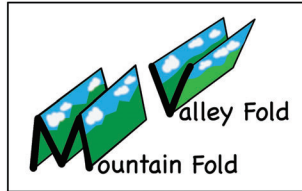

A mountain fold is an upside down valley fold.



A single pointed arrow shows the starting and ending point of a fold.

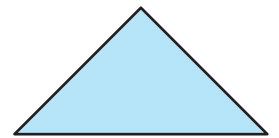
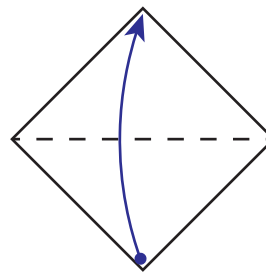

When a single pointed arrow is shown with a mountain fold, send the top of the paper to the back of the model.

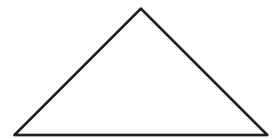
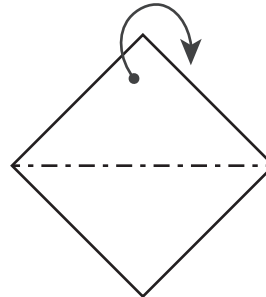

An arrow with two points tells you there are two steps! First make the fold as shown. Next, unfold the paper.

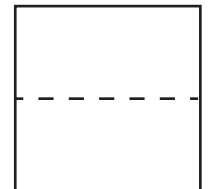
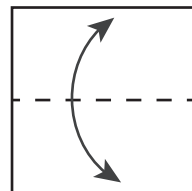

The loop-the-loop arrow tells you to flip over the model.

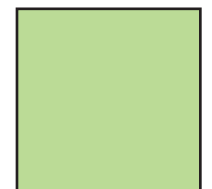
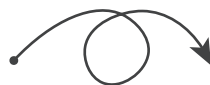

Links to Fun Frogs and Cute Chickens

Easy Frog

Less Easy Frog

Frog using A4 paper!

Hen

Easy Hen

Another Hen

Round Hen

Terms of Use

By downloading this product, you agree that the contents are the property of Isabelle Hoag M. Ed., Director of Education at UnCommon-Core.com and licensed to you only for classroom/personal use as a single user. I retain the copyright, and reserve all rights to this product.

YOU MAY:

- Use this product with your own students, in your classroom, or for your own personal use.
 - Reference this product in blog posts, professional development workshops, at seminars, or other similar venues, ONLY if both credit is given to me as the author and a link to UnCommon-Core.com is included.
 - Please direct others to my TPT store UnCommon-Core dot com where they can download their own copy.
-

YOU MAY NOT:

- Claim this work as your own, alter the files in any way or remove copyright/watermarks.
 - Sell the files or combine them into another unit for sale or for free.
 - Post this document for sale or free elsewhere on the internet including Google Doc links on blogs.
 - Make copies of this product to share with others.
-

Thank you for following universally accepted codes of professional ethics while using this product. If you have any issues with the file, or notice an error please contact me and I will be happy to help sort it out.

Thank you!

Isabelle@UnCommon-Core.com